

TA Series Analog Setting Non-Indicating type, PID Control

Analog and non-indicating type, PID control, set temperature by dial

■ Features

- Improved control performance with built-in microcomputer
- Adopting new Auto-tuning PID control algorithm : Selectable ON/OFF, PID control (with the external slide SW)
- Easy to check controlling status with deviation indicating lamp : Deviation LED(red, green), output LED(red) indicator
- Dial setting output OFF function
- Sensor broken display function

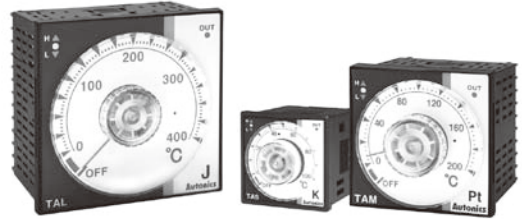

⚠ Please read "Caution for your safety" in operation manual before using.



(Pending)

■ Ordering information

TA S - B 4 R P 4 C

Unit	C	Celsius °C			
	F	Fahrenheit °F			
Temperature range for each sensor		°C	°F	Temperature sensor	
	0	-50 to 100	-58 to 212	Pt	— —
	1	0 to 100	32 to 212	Pt	— K
	2	0 to 200	32 to 392	Pt	J K
	3	0 to 300	32 to 572	—	J —
	4	0 to 400	32 to 752	Pt	J K
	6	0 to 600	32 to 1,112	—	— K
	8	0 to 800	32 to 1,472	—	— K
	C	0 to 1,200	32 to 2,192	—	— K
Sensor input type	P	DPt100Ω			
	J	J(IC)			
	K	K(CA)			
Control output	R	Relay output			
	S	SSR drive voltage output			
Power supply	4	100-240VAC 50/60Hz			
	B	ON/OFF control & PID control combined			
Control method	S	DIN W48 x H48mm(8pin plug type) ^{※1}			
	M	DIN W72 x H72mm			
	L	DIN W96 x H96mm			
Size	L	DIN W96 x H96mm			
	M	DIN W72 x H72mm			
Item	L	DIN W96 x H96mm			
	M	DIN W72 x H72mm			
Item	TA	Analog setting type temperature controller			

※1: 8pin socket(PG-08, PS-08) is sold separately.

(A)	Photo electric sensor
(B)	Fiber optic sensor
(C)	Door/Area sensor
(D)	Proximity sensor
(E)	Pressure sensor
(F)	Rotary encoder
(G)	Connector/Socket
(H)	Temp. controller
(I)	SSR/ Power controller
(J)	Counter
(K)	Timer
(L)	Panel meter
(M)	Tacho/ Speed/ Pulse meter
(N)	Display unit
(O)	Sensor controller
(P)	Switching mode power supply
(Q)	Stepper motor& Driver&Controller
(R)	Graphic/ Logic panel
(S)	Field network device
(T)	Software
(U)	Other

TA Series

Specifications

Series	TAS	TAM	TAL
Power supply	100-240VAC 50/60Hz		
Allowable voltage range	90 to 110% of rated voltage		
Power consumption	Max. 4VA		
Size	DIN W48×H48mm	DIN W72×H72mm	DIN W96×H96mm
Display method	Deviation LED(red, green), Output LED(red)		
Setting type	Dial setting		
Setting accuracy ^{※1}	F.S. ±2% (room temperature 23°C±5°C)		
Input type	RTD	DPT100Ω (allowable line resistance max. 5Ω per a wire)	
	Thermocouples	K(CA), J(IC)	
Control	ON/OFF Control	Hysteresis: 2°C fixed	
	PID Control	Control period: Relay output - 20 sec. / SSR drive voltage output - 2 sec.	
Control output	Relay	250VAC 3A 1c	
	SSR	12VDC±2V 20mA Max.	
Functions	PV deviation indicatable, Error indicatable		
Dielectric strength	2,000VAC 50/60Hz for 1min.(between input terminal and power terminal)		
Vibration	0.75mm amplitude at frequency of 5 to 55Hz(for 1 min.) in each of X, Y, Z directions for 2 hours		
Relay life cycle	Mechanical	Min. 10,000,000 operations(18,000 operations/hr)	
	Electrical	Min. 100,000 operations(900 operations/hr)	
Insulation resistance	Min. 100MΩ(at 500VDC megger)		
Noise resistance	±2kV R-phase, S-phase the square wave noise (pulse width: 1us) by the noise simulator		
Memory retention	Approx. 10 years (when using non-volatile semiconductor memory type)		
Environment	Ambient temperature	-10 to 50°C, storage: -20 to 60°C	
	Ambient humidity	35 to 85%RH, storage: -35 to 85%RH	
Unit weight	Approx. 65g	Approx. 378g	Approx. 387g

※1: Out of room temperature range: Below 100°C model is F.S. ±4% , Over 100°C model is F.S. ±3%

※Environment resistance is rated at no freezing or condensation.

Connections

※RTD: DPT100Ω(3-wire type) ※Thermocouple: K(CA), J(IC)

● TAS

(※Socket(PG-08, PS-08) is sold separately)

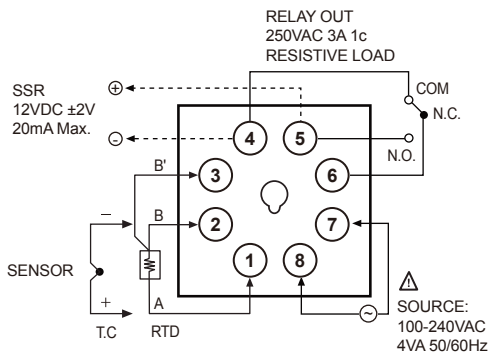

● TAM

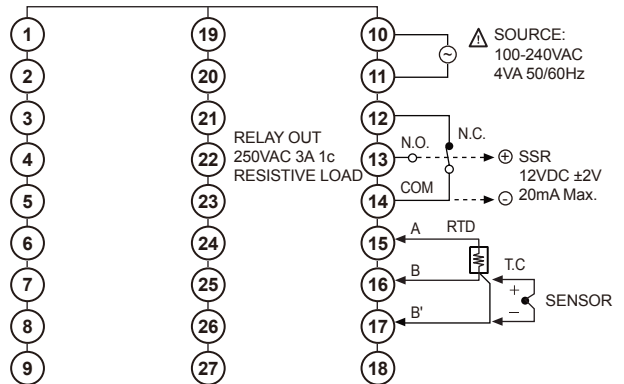

Analog Setting Non-Indicating type, PID Control

■ Connections

※RTD: DP1100Ω (3-wire type) ※Thermocouple: K(CA), J(IC)

● TAL

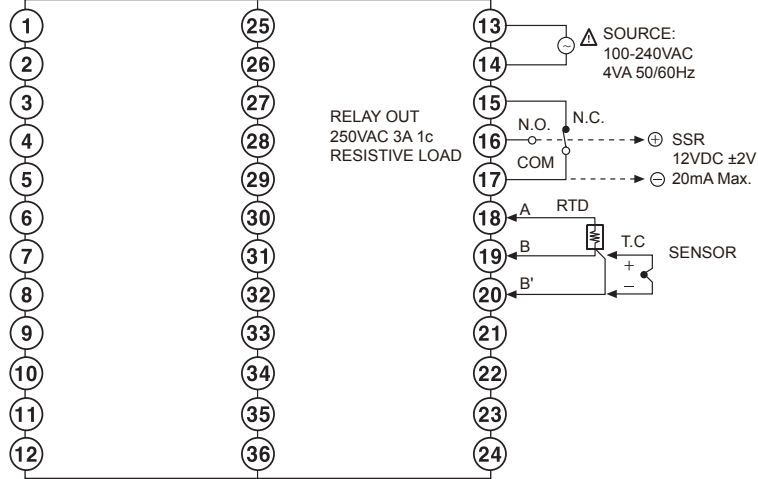

■ Dimensions

(unit: mm)

● TAS

<Bracket>

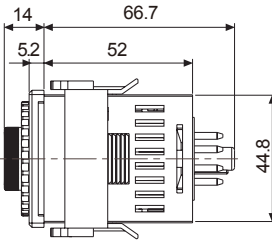
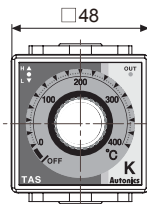
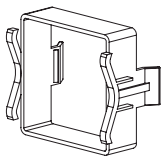

● Panel cut-out

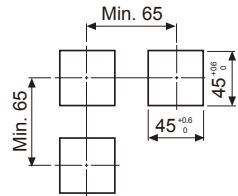

● TAM

<Bracket>

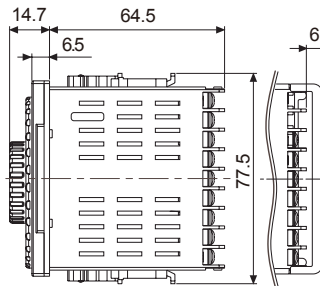
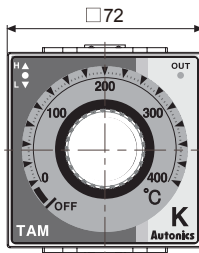
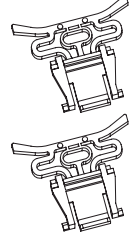

● Panel cut-out

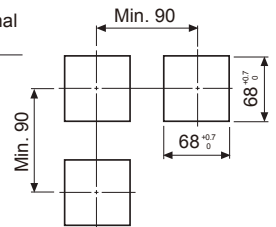

● TAL

<Bracket>

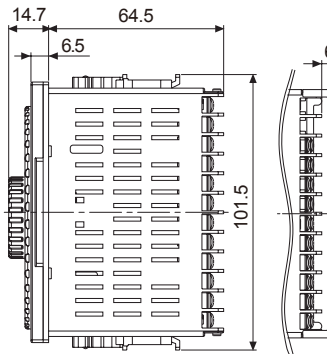
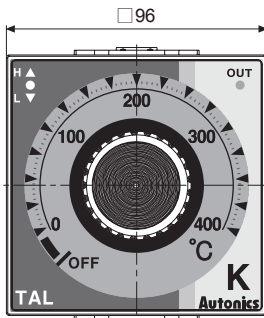
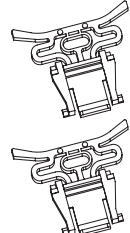

● Panel cut-out

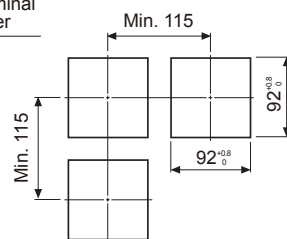

(A) Photo electric sensor

(B) Fiber optic sensor

(C) Door/Area sensor

(D) Proximity sensor

(E) Pressure sensor

(F) Rotary encoder

(G) Connector/Socket

(H) Temp. controller

(I) SSR/Power controller

(J) Counter

(K) Timer

(L) Panel meter

(M) Tacho/Speed/Pulse meter

(N) Display unit

(O) Sensor controller

(P) Switching mode power supply

(Q) Stepper motor& Driver&Controller

(R) Graphic/Logic panel

(S) Field network device

(T) Software

(U) Other

TA Series

● Terminal cover(sold separately)

- RMA-COVER (72×72mm)

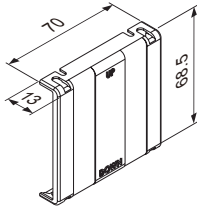

- RLA-COVER (96×96mm)

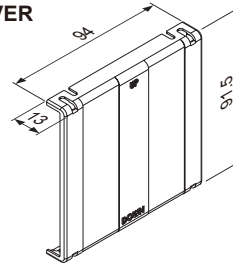

(unit: mm)

■ Parts description

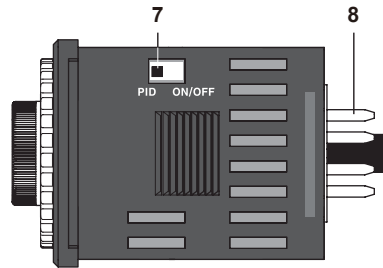
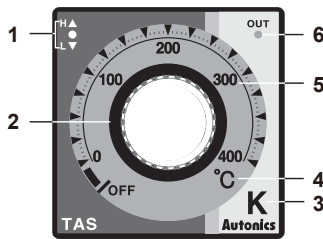

1. Deviation indicator: It shows deviation of present temperature(PV) based on set temperature(SV) by LED.
Input deviation indicator [Deviation indicator: ● (green), ▲/▼ (red)]

No	PV deviation temperature	Deviation indicator	No	PV deviation temperature	Deviation indicator
1	Input sensor OPEN	▲+●+▼ Lamp flash (every 0.5 sec.)	5	Below ±2°C	● Lamp lights
2	Exceed max. input value	▲ Lamp flashes (every 0.5 sec.)	6	-2°C to -10°C	●+▼ Lamp light
3	Over 10°C	▲ Lamp lights	7	Over -10°C	▼ Lamp lights
	2°C to 10°C	▲+● Lamp light	8	Less than min. input value	▼ Lamp flashes (every 0.5 sec.)

※This is the same as Fahrenheit(°F).

※When power is on, all lamps light for 2sec., then all lamps turn off and control operation starts.

2. Set temperature(SV) dial:

Dial to change set temperature (SV). When changing set temperature, it is applied after 2 sec. for the stable input.

3. Input sensor type:

Indicates sensor type of present value. Input sensor type or input range each product is shown in the below table.

Input sensor		Range No.	Temperature range (°C)	Temperature range (°F)
Thermocouple	K(CA)	1	0 to 100	32 to 212
		2	0 to 200	32 to 392
		4	0 to 400	32 to 752
		6	0 to 600	32 to 1,112
	J(IC)	8	0 to 800	32 to 1,472
		C	0 to 1,200	32 to 2,192
		2	0 to 200	32 to 392
		3	0 to 300	32 to 572
RTD	DPt100Ω	4	0 to 400	32 to 752
		0	-50 to 100	-58 to 212
		1	0 to 100	32 to 212
		2	0 to 200	32 to 392
		4	0 to 400	32 to 752

※Set temperature within input range each sensor.

4. Temperature unit indicator: Indicates temperature unit(°C, °F) of set temperature(SV) and present value(PV).

5. Temperature range indicator: Indicates temperature range of set temperature(SV).

6. Control output indicator lamp: Light when control output(Relay output/SSR voltage output).

7. Control mode selector switch: Select PID control or ON/OFF control using switch.

8. Terminal: Terminals for external connections. For detail, refer to ■ Connections.

Analog Setting Non-Indicating type, PID Control

Product mounting

● TAS(48×48mm) Series

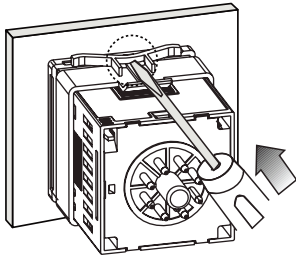

※Mount the product on the panel, fasten bracket by pushing with tools as shown above.

● Other Series

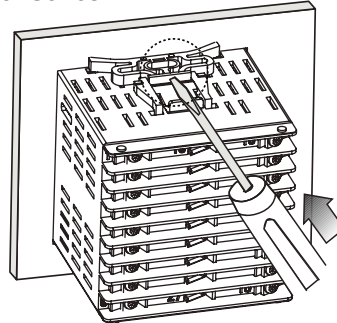

Functions

● SSR drive voltage output

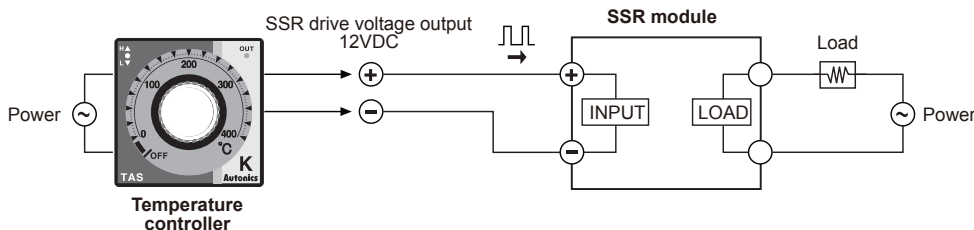

● ON/OFF control

ON/OFF control function is for controlling temperature by comparing present temperature(PV) to setting temperature(SV). ON/OFF control is fixed on reverse operation(Heating).

Output turns on to supply power to heater when present temperature(PV) falls lower than setting temperature(SV) and the output turns off to turn off heater when present temperature(PV) is higher than setting temperature(SV).

※Hysteresis is fixed 2°C during ON/OFF control.

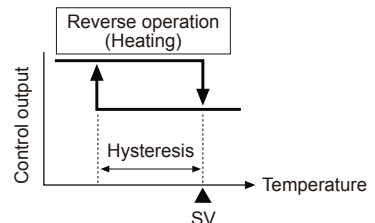

● PID control

PID constants are suggested and implemented based on self tuning from supply power until reaching set temperature(SV), then self tuning is over after reaching set temperature(SV).

When power supply, in case that set temperature(SV) dial points at OFF or self tuning can not be started because present temperature (PV) is higher than set temperature(SV) or hunting occurs during self tuning, output control is switched to proportion band(P) because that is considered to error. At that time, proportion band is fixed at 10°C.

※Control cycle of PID control and proportion control is 20 sec. in relay output model and 2 sec. in SSR voltage output.

● STOP

Control output could stop without power off by setting the front setting volume to below min. setting range.

If control output stops by STOP function, Green lamp in deviation indicator(●) will flash every 1sec.

● Error

Error mark will flash(every 1sec.) in PV indicator when error occurs during the control operation.

It will operate normally, if input sensor is connected or returned to normal range.

No	Display	Description
1	▲+●+▼ Lamp flash	If input sensor line is broken or sensor is not connected.
2	▲ Lamp flashes	If measured sensor input is higher than temperature range.
3	▼ Lamp flashes	If measured sensor input is lower than temperature range.

(A) Photo electric sensor

(B) Fiber optic sensor

(C) Door/Area sensor

(D) Proximity sensor

(E) Pressure sensor

(F) Rotary encoder

(G) Connector/Socket

(H) Temp. controller

(I) SSR/ Power controller

(J) Counter

(K) Timer

(L) Panel meter

(M) Tacho/ Speed/ Pulse meter

(N) Display unit

(O) Sensor controller

(P) Switching mode power supply

(Q) Stepper motor& Driver&Controller

(R) Graphic/ Logic panel

(S) Field network device

(T) Software

(U) Other